

Driving Intention Identification Based on Neural Network Optimized by Particle Swarm Optimization

Min Li*, Xilong Zhang, Yongliang Zhang, Dayi Qu and Fuquan Pan

Qingdao University of Technology, School of Mechanical and Automotive Engineering 266520

Electroencephalograph (EEG) signals received from different areas of the human brain were analyzed using a combination of theoretical analysis, experimentation and simulation. The driving simulation experiment was designed, and an acquisition system was set up to collect EEG signals when drivers in the experiment turned left, turned right, or proceeded straight within a specified time window. The collected EEG signals were processed, through wavelet package transform and other signal processing methods, to extract their feature parameters. The models, based on a Support Vector Machine (SVM) model optimized by Particle Swarm Optimization (PSO) and on a Neural Network (NN), were built to recognize motorists' driving intentions through the processed EEG signals. The recognized driving intention with better recognition rate was transformed into corresponding instruction signal which can control the vehicle to achieve automatic drive. The analysis and result shows that the recognition rate of the model based on SVM optimized by PSO increases to 73.5%, and that of the model based on NN achieves a better rate of 92.9%.

Keywords: Brain–Computer Interface (BCI); Driving Intention Recognition; Particle Swarm Optimization (PSO); Support Vector Machine (SVM); Neural Network (NN); Automotive Driving

IH Kim et al. studied joint features based on the electroencephalogram (EEG) to predict the driver's intention when braking.¹ Zhang H. et al. used EEG changes to predict the driver's turn direction before reaching a road junction.² Stefan Haufe et al. proposed the use of EEG over EMG to quickly predict the driver's emergency braking intention.³ Welke S. et al. used EEG to predict the driver's intended actions.⁴ Gheorghel L. et al. studied the time required to predict driving

tasks through EEG.⁵ I.H. Kim et al. identified driver's braking intention through the analysis of EEG data⁶. Ikenishi T. et al. identified and judged the driver's vertical behavior characteristics⁷ and steering intention through the driver's EEG.⁸ Bi L. et al. proposed the use of brain signals instead of four limbs to control vehicles.⁹ Tang T et al. proposed the use of EEG signals to identify emergencies via the power spectrum of 13 channels of EEG signals for calculation.¹⁰

The present study mainly used a wavelet package to analyze

*Corresponding Author. E-mail: lingzi790211@163.com

EEG data and the energy proportion of each waveform of the brain as input parameters to the recognition model to identify the driving intention. It then inputs the recognition results to the vehicle CAN bus to achieve self-driving.

1. EXPERIMENTAL ANALYSIS

When the human brain is stimulated by external factors or produces motion awareness, numerous nerve cells generate weak electrical activity measuring several tens of millivolts. The electrical activity of these nerve cells is transmitted to the surface of the scalp to form brain waves, which are then reflected by some kind of rhythm and spatial distribution. These characteristic signals are extracted through an instrumental equipment acquisition system for detection, analysis, and processing, and are then used to identify the behavioral intentions that trigger EEG changes. Computer language is then utilized to program the changes and convert human thinking activities into command signals to drive external devices and enable the human brain to control the external environment.

By placing a detection electrode on the scalp, EEG detects human intention by detecting the activity of the brain through the potential distribution of hundreds of millions of cerebral cortical neurons populating the surface of the scalp.

1.1 Experiment objectives and methods

Ethics statement: The study was approved by the Institutional Review Board of Qingdao University of Technology, China. All participants provided written informed consent.

Experiment: The test driver tests the driver's EEG signals under a typical urban environment, such as turning left, turning right, and proceeding straight ahead. The driver's EEG signals are tested through the EEG device g. USBamp, and the data are stored and analyzed to extract EEG features. The feature values are then identified by using a recognition model.

Experiment methods: Through a virtual simulation simulator, a typical section of a city road was established. Ten drivers used hardware devices including steering wheel, shift lever, accelerator pedal and brake pedal to perform normal driving operations under virtual simulation conditions. For testing purposes, all drivers had an electrode cap with 16 electrodes fitted to their heads. Each driver drove twice to test the 16 electrodes, taking a ten-minute break between tests. The EEG signals data were saved.

Each driver's EEG signals were tested by the EEG device g.USBamp to analyze the driver's intentions based on the data.

1.2 Allocation and Analysis of EEG Data

To test each driver's EEG signal and obtain EEG data, each intention sample was divided into three sections.

① Some of the EEG data was used as training data. Specifically, mainly the learning samples were used to train the model, and then the model parameters were obtained. This trained model was used to validate the model.

② Some of the EEG data was used as verification data. This part of the data was mainly used to validate the trained model.

③ Some of the EEG data was used as test data. The recognition model described in the following sections was used to identify and determine the driver's driving intention.

2. EEG FEATURE EXTRACTION

There are four main types of EEG signals: θ -wave, α -wave, β -wave, and γ -wave. The wavelet packet technique is used to extract the characteristic parameters of these waveform types. The basic idea of the wavelet packet is to decompose the wavelet subspace in a multi-resolution analysis. Several kinds of wavelet bases can be selected for classification. For this study, a function with high classification efficiency was selected as the wavelet basis function. Given that the graph of db1 is similar to the EEG signal graph, the function db1 was chosen as the wavelet basis function.

The wavelet packet decomposition node consists of θ -wave: 4–8 Hz, node 32; α -wave: 8–13Hz, node 33, 139; β -wave: 13–30 Hz, nodes 140, 70, 37, 77; γ -wave: 30–60 Hz, nodes 78, 9, 21, 45.

The seventh layer needs to be decomposed, while the points that do not need to be broken down include 2, 9, 15, 17, 21, 33, 37, 45, 46, 70, 77, and 78.

Based on the energy characteristics of θ -wave, α -wave, β -wave, and γ -wave in the EEG signals, during the driving process of the driver, the energy of the four frequencies is clearly extracted through wavelet packet decomposition. Furthermore, the energy ratio of each waveform is used as an input parameter and is then input into a recognition model to identify the driving intention. The 16 channels of the waveform of the driver's intention category, each waveform, each wave energy, the ratio of each energy, and the tree diagram of each wave are organized together using Matlab programming. The characteristics of each factor are also displayed based on the different needs and the characteristic values of the energy are obtained. Using the F3 channel as an example, Figures 2, 3, and 4 illustrate the calculation of the left-turn intention energy of each band.

The energy proportions of the four waveforms obtained are used as input parameters, and the input recognition model is employed to identify the driving intention.

3. PARTICLE SWARM OPTIMIZATION SUPPORT VECTOR MACHINES AND NEURAL NETWORK ANALYSIS

With the use of the support vector machine (SVM) model for classification and identification, the penalty factor c and the learning factor g are shown to have considerable influence on the classification effect of the SVM. In the SVM model, the determination on parameters of penalty factor c and learning factor g is achieved through experience, which will inevitably affect the recognition results and accuracy of the SVM model. Therefore, particle swarm algorithm is used to find the optimal value for the penalty factor c and the parameter g , and the use of this algorithm to optimize the parameters of SVM can improve its training efficiency.

In the process of particles updating themselves, the math-

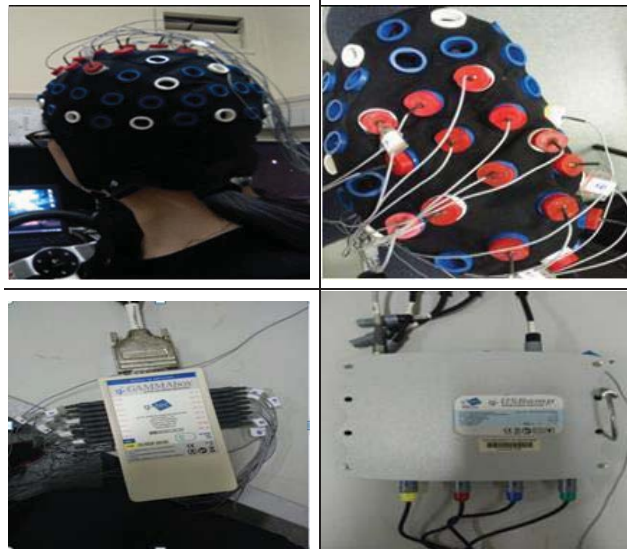

Figure 1 Equipment used for the experiment.

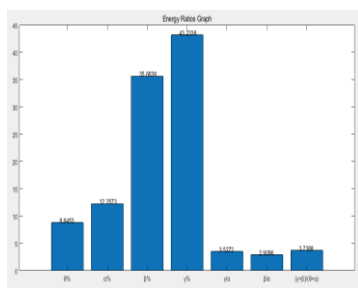

Figure 2 Energy ratio of each waveband when left-turning.

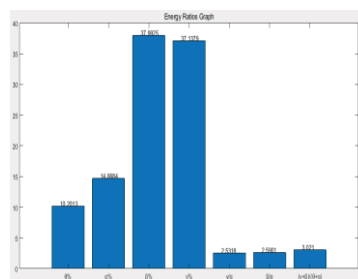

Figure 3 Energy ratio of each waveband when right-turning.

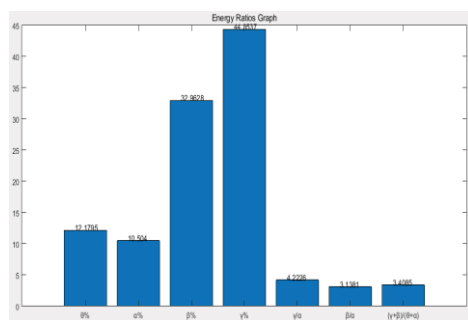

Figure 4 Energy ratio of each waveband when straight-driving.

follows:

$$V_{id}^{k+1} = \omega V_{id}^{k+1} + c_1 r_1 (P_{id}^k - X_{id}^k) + c_2 r_2 (P_{gd}^k - X_{id}^k) \tag{1}$$

$$X_{id}^{k+1} = X_{id}^k + V_{id}^k \tag{2}$$

In the formula, ω is the inertia weight, $d = 1, 2, \dots, D$; $i = 1, 2, \dots, n$; k is the current number of iterations; V_{id} is the velocity of the particle; c_1 and c_2 are the acceleration factors; and r_1 and r_2 are random numbers.

Wavelet packet decomposition is used for denoising and reconstructing, and Matlab is used to obtain the energy distribution of each band and the energy ratio of each band. These 11 parameters are utilized for the input parameter input identification model through the SVM model, which is optimized by the particle swarm optimization algorithm, for training and classification to identify the driver's intentions.

Table 1 Results of driving intention recognition.

Type of driving intention	Recognition rate
Left-turning and Right-turning	73.53%
Left-turning and Straight-driving	66.67%
Right-turning and Straight-driving	68.57%

The weights and thresholds of the input and output layers of the neural network are determined randomly, and greatly influence the classification or prediction of neural networks. The optimal weights and thresholds of the input and output layers of the neural network are used to identify the driving intention by using the neural network model with the optimal weights and thresholds.

The neural network mainly consists of an input layer, an implicit layer, and an output layer. The activation value of

emational model that uses the particle swarm algorithm is as

each neuron in the hidden layer is as follows:

$$s_k = \sum_{j=1}^p v_{kj} \cdot b_j - \theta_k \quad (j = 1, 2, \dots, p) \quad (3)$$

where w_{ji} is the connection right from the input layer to the hidden layer, and θ_j is the threshold of the hidden layer unit.

The activation function uses the S-type function, which is continuously differentiable and is closer to the signal output form of biological neurons than other functions. The S-type function is:

$$f(x) = \frac{1}{1 + \exp(-x)} \quad (4)$$

The activation value is substituted into the activation function to obtain the output value of the hidden layer j element:

$$b_j = f(s_j) = \frac{1}{1 + \exp(-\sum_{i=1}^n w_{ji} \cdot x_i + \theta_j)} \quad (5)$$

in which θ_j is the threshold.

The activation value of the k^{th} element of the output layer is

$$s_k = \sum_{j=1}^p v_{kj} \cdot b_j - \theta_k \quad (6)$$

The actual output value of the k^{th} unit of the output layer is as follows:

$$y_k = f(s_k) \quad (k = 1, 2, \dots, q) \quad (7)$$

In the formula, $\Delta\theta_j = \beta \cdot e_j$ is the weight of the hidden layer to the output layer, θ_k is the output layer unit threshold, and $f(x)$ is the S-type activation function.

Take the neural network recognition of the particle swarm algorithm of the left-turn intentions of the left hemisphere (16 channels) and the straight-ahead-driving intentions (left hemisphere F1 channel) as an example. The recognition rate of the left-turn intention test reached 92.9%. The training recognition rate reached 85.1%, and the overall recognition rate was 84.2%, as shown in Figures 8 and 9. For the neural network recognition of particle swarm optimization of the left-hemisphere (16-channel) left-turn intentions and right-turn intentions (left hemisphere F1 channel), the left-turn intention and right-turn intention test recognition rates reached 85.7%, training recognition rates reached 76.7%, and the overall recognition rate was 77.5%. For the left-hemisphere (16-channel) right-turn intentions and straight-driving intentions (left hemisphere F1 channel), the right-turn intention and straight-driving intention test recognition rates reached 90.5%, training recognition rates reached 82.5%, and the overall recognition rate was 82.7%.

4. SELF-DRIVING ANALYSIS

Through the recognition of the driving intention of the particle swarm optimization algorithm's SVM and the neural network's driving intention recognition based on the particle swarm algorithm, we conclude that the best recognition

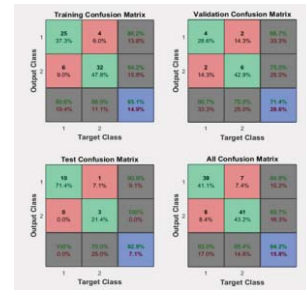

Figure 5 Confusion chart of driving intention recognition of left-turning and straight-driving.

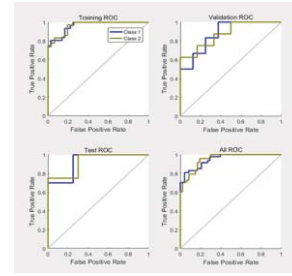

Figure 6 ROC curve of driving intention recognition of left-turning and straight-driving.

effect is the neural network's driving intention recognition of the particle swarm algorithm and the virtual obtained driver. The intention signal is converted into a command input to the CAN bus control section of the vehicle to achieve self-driving of the vehicle.

The EEG control of the machine is a process of signal recognition. This process uses the processing of the microprocessor to set the steering signal to either "0" or "1" and then send this data to the execution system.

Through the neural network identified by the particle swarm algorithm, the left-turn intention, right-turning intention, and driving straight intention EEG signals are converted into corresponding commands and passed to the CAN control system to realize the driver's intention and achieve the purpose of self-driving as shown in Figure 7.

In Figure 7, the human participation is set to be "node 1," and the exchange of information is completed through the CAN controller. "Node 2," "Node 3," and "Node 4" can be set respectively as a rotation angle sensor, a speed sensor, and a distance sensor, while the other nodes are various sub-modules in the vehicle system.

5. CONCLUSION

This study establishes an SVM driving intention recognition model and uses the particle swarm optimization algorithm to optimize the key parameters of the model, penalty factor c , and kernel function g . The objective function of the SVM recognition model is a fitness function. Parameters such as extracted energy and energy ratio are used as the model's input parameters, and the recognition accuracy of driving intentions according to left turn and right turn, straight-ahead driving and left turn, straight-ahead driving and right turn can reach

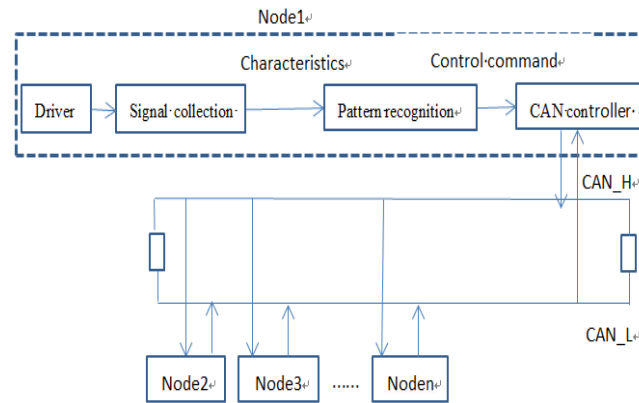

Figure 7 BCI and CAN-BUS system structure.

73.53%.

In this work, a neural network driving intention recognition model is also established, and the particle swarm optimization algorithm is employed to optimize the input layer weights and thresholds, as well as output layer weights and thresholds of the key parameters of the model. The accuracy rate identified by the neural network is taken as the fitness value. The neural network identification model takes the characteristic parameters of each band as input parameters. The recognition accuracy of driving intentions according to left turn and right turn, straight-ahead driving and left turn, straight-ahead driving and right turn can reach 92.9%.

The EEG signals collected through brain-computer interface technology are processed and analyzed for EEG signals, and characteristic parameters are input to the recognition model to identify them and increase the recognition rate. The goals of this study are to provide both theoretical and practical support for traffic safety in self-driving, to avoid traffic risks, or to realize assisted driving.

REFERENCES

1. Kim, I. H., Kim, J. W., Haufe, S., & Lee, S. W. Detection of braking intention in diverse situations during simulated driving based on EEG feature combination. *Journal of Neural Engineering*[J].2014.12(1):016001.
2. Zhang H, Chavarriaga R, Khaliliardali Z, Gheorghe L, Iturrate I, d R Millán J. EEG-based decoding of error-related brain activity in a real-world driving task[J]. *Journal of Neural Engineering*. 2015 Nov 24.12(6):066028.
3. Haufe, S., Treder, M. S., Gugler, M. F., Sagebaum, M., Curio, G., & Blankertz, B. (2011). EEG potentials predict upcoming emergency brakings during simulated driving[J]. *Journal of Neural Engineering*,2011.8(5), 056001.
4. Welke, S., Jurgensohn, T., & Roetting, M. Single-trial detection of cognitive processes for increasing traffic safety. In *Proceedings: International Technical Conference on the Enhanced Safety of Vehicles*. National Highway Traffic Safety Administration. Vol.2009.
5. Gheorghe, L., Chavarriaga, R., & Millán, J. D. R. Steering timing prediction in a driving simulator task. In *Engineering in Medicine and Biology Society (EMBC), 2013 35th Annual International Conference of the IEEE[C]*.2013(7) :6913-6916.
6. Kim, I. H., Kim, J. W., Haufe, S., & Lee, S. W. Detection of multi-class emergency situations during simulated driving from ERP. In *Brain-Computer Interface (BCI), 2013 International Winter Workshop on*,2013(2): 49-51.
7. Ikenishi, T., Kamada, T., & Nagai, M. Analysis of longitudinal driving behaviors during car following situation by the driver's EEG using PARAFAC. *IFAC Proceedings Volumes*, 2013,46(15):415-422.
8. Ikenishi, T., Kamada, T., & Nagai, M. Classification of Driver Steering Intention Based on Brain-Computer Interface Using Electroencephalogram (No. 2007-01-3511). *SAE Technical Paper*.
9. Bi, L., Lu, Y., Fan, X., Lian, J., & Liu, Y. Queuing Network Modeling of Driver EEG Signals-Based Steering Control. *IEEE Transactions on Neural Systems and Rehabilitation Engineering*. 2017.25(8):1117-1124.
10. Teng, T., Bi, L., & Fan, X. A.. Using EEG to recognize emergency situations for brain-controlled vehicles. In *Intelligent Vehicles Symposium (IV), 2015 IEEE*. IEEE. 2015(6):1305-1309.

