

Design of Hybrid Energy Storage Capacitance Control System Based on Microgrid

Tao Wang* and Hailin Hu

School of Electrical Engineering and Automation, Jiangxi University of Science and Technology, Ganzhou 341000, China

The energy storage device is vital to the smooth operation of the capacitor power and optimize the power quality. A hybrid energy storage capacitor control system based on the microgrid is designed. The battery pack and the super capacitor in the system hardware are connected in parallel through the DC/DC converter. When the mixed storage energy of the microgrid is abnormal, the F28M35 central control chip collects the data of the battery pack and the Super capacitor, completing the charge and discharge control of super capacitors and batteries. After analyzing the detailed information of the super capacitor, the control strategy of parallel bidirectional DC/DC converter is adopted to achieve the hybrid capacitance control of the microgrid. The experimental results show that the average capacitance stability of the system is 99.99 %, and the convergence speed is fast. After controlling 7 ms, the active power of the microgrid tends to be stable, and the capacitance power of the microgrid can be guaranteed to run smoothly.

Keywords: Microgrid; Mixing; Energy storage; Capacitors; Control; Battery

1. INTRODUCTION

In recent years, with the increasing concerns about environmental protection and the depletion of natural resources, renewable energy sources – solar, wind and tidal -have become significant energy-generating options. However, these sources of renewable energy are affected by factors in the natural environment such as climatic conditions, which renders them unreliable and inconsistent in terms of generating energy [1]. When these types of renewable energy sources are connected to the grid, the security and reliability of power grid is poor [2]. The microgrid is a system established by load and a micro source, which can provide energy at the same time. With the gradual maturity of microgrid technology, microgrid energy storage has become a hot issue for relevant technicians [3].

Micro source in a microgrid mainly involves wind turbines and photovoltaic cells. However, these micro sources are influenced by wind power and light intensity; thus, the output

power is unstable [4]. Therefore, the instability of output power must be reduced by means of an energy storage link. Battery energy storage, pumped energy storage, and super capacitor energy storage can be used as the energy storage link. In order to overcome the disadvantages of single-energy storage, the super capacitor and battery are combined to construct a hybrid energy storage system that can improve the reliability of the power supply. In this paper, a hybrid energy storage capacitor control system based on the microgrid is established to ensure the safe and stable operation of microgrid and optimize the power supply.

2. HYBRID ENERGY STORAGE CAPACITOR CONTROL SYSTEM

2.1 The Design of System Hardware

The hybrid energy storage capacitor control system based on the microgrid transmits the power between the energy

*Email: wt309172182@163.com

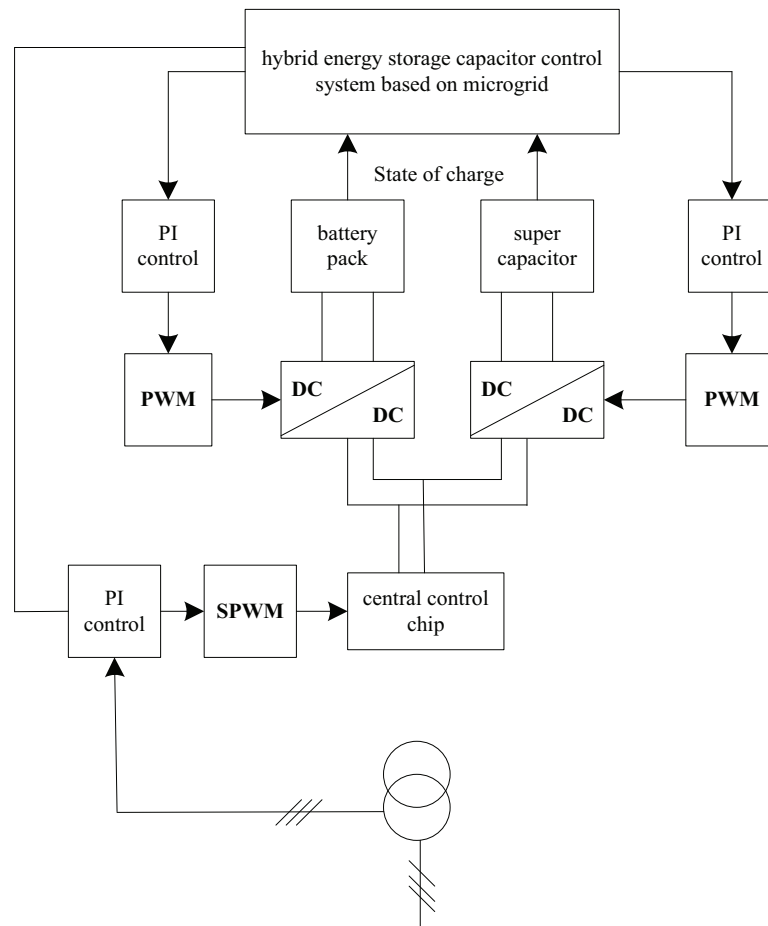

Figure 1 The Overall Structure of Hybrid Energy Storage Capacitor Control System Based on Microgrid

storage device and microgrid through a PI control inverter, and maintains the stability of the system power [5]. At the same time, it can also optimize the power of the battery and super capacitor, which is also the core of energy management of capacitor control system in a hybrid energy storage system based on the microgrid. The central control chip is mainly used to determine the charging situation of super capacitor and battery, optimize the charge and discharge performance of super capacitor and battery, and ensure the stable operation of the microgrid [6]. In the control system of the hybrid energy storage capacitor, the battery and super capacitor are connected in parallel through the DC/DC converter. If the hybrid energy storage of the microgrid is abnormal, the central control chip collects the battery and super capacitor data in order to control the charge and discharge of the super capacitor and battery.

The overall structure of hybrid energy storage capacitor control system based on microgrid is shown in Figure 1.

(1) F28M35 central control chip

The central control chip in the system uses a F28M35 central control chip, which can collect real-time switch status, IGBT temperature information, battery status and super capacitance data. Its data calculation and processing performance is high. Even in the complex control program, it still has a strong control effect, and can calculate the current PWM duty cycle in time, and

control the charge and discharge of the super capacitor and battery [7].

The structure of F28m35 central control chip is shown in Figure 2 below.

(2) Battery pack

As shown in Figure 3, the battery management unit (BMU) and a set of battery management sections (BMS) are set in the battery pack. A BMU manages a series battery pack. The BMU collects the data in regard to battery voltage, current, temperature, insulation resistance, etc. The BMS collects all BMU data, monitors the condition of the entire battery pack, and manages protection and all warnings. Generally, self-equalization technology is used in the battery pack [8].

(3) Super capacitor

In the control system of hybrid energy storage capacitor, the control of the super capacitor involves the DC/DC converter and DC / AC converter. The bi-directional DC/DC converter converts the energy between the super capacitors on the side of DC low voltage and that on the side of DC high voltage by means of a two-stage PI control module and a PWM control module. The control object of the DC/DC converter needs to meet the power constraint of the super capacitor [9]. Its control structure is shown in Figure 4:

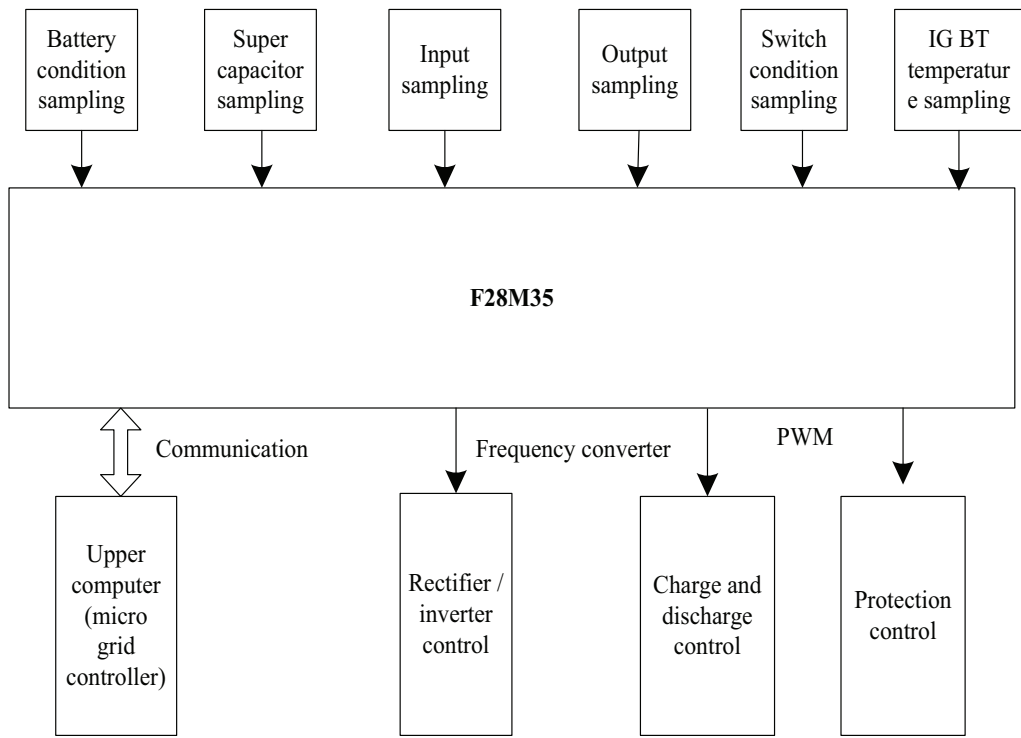

Figure 2 The Structure of F28M35 Central Control Chip

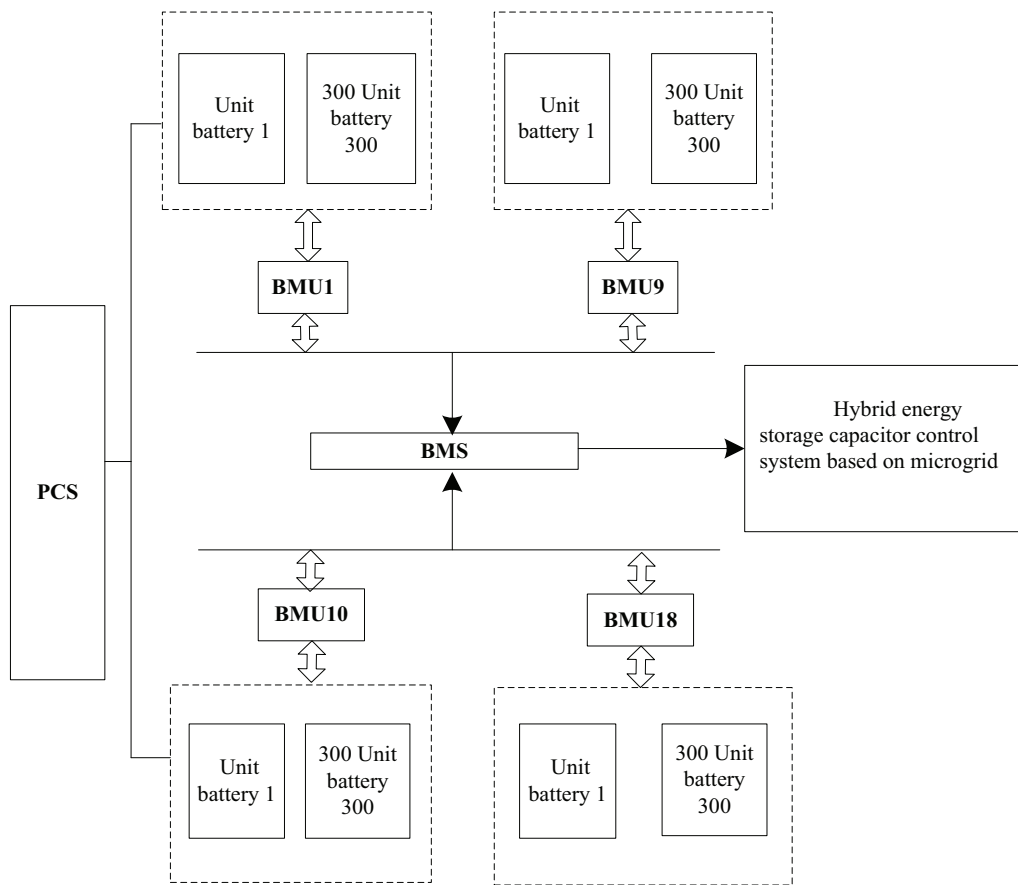

Figure 3 The Structure of Battery Pack

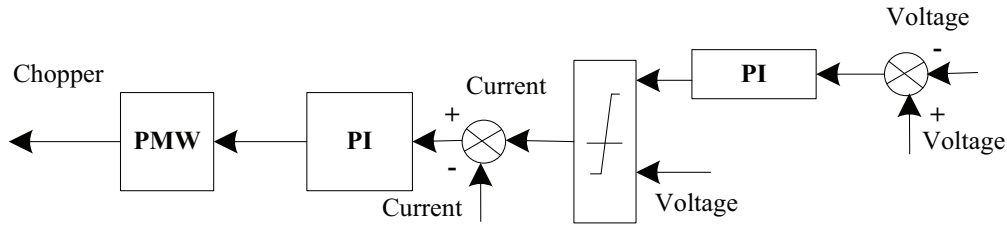

Figure 4 Control Structure of DC/DC Converter

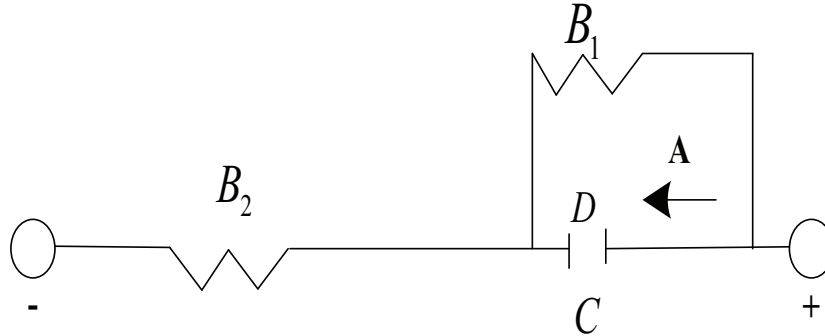

Figure 5 The Model of the Super Capacitor

2.2 The Design of the System Software

2.2.1 The Model of the Super Capacitor

In the control system of the hybrid energy storage capacitor, the structure of the super capacitor is complex, so it needs to be modeled according to its environment. In the system, the design is made according to the hybrid energy storage environment of battery and super capacitor. The super capacitor model is shown in Figure 5:

As shown in Figure 5, the terminal voltage of the super capacitor is set as C ; the capacity of the super capacitor is set as D ; the equivalent parallel resistance and the equivalent series resistance are set as B_1 and B_2 respectively; Resistance B_1 is used to describe the internal voltage drop and internal heating inside the super capacitor after power on, with a small value, which is often taken as a constant; resistance B_2 is used to describe the natural discharge, with a large value.

The capacity D of the super capacitor and equivalent series resistance B of the super capacitor are both functions of the charge discharge current A and the electrolyte temperature E_c :

$$\begin{cases} D = g(A, E_c) \\ B = g(A, E_c) \end{cases} \quad (1)$$

During charging and discharging process, the terminal voltage C and ideal capacitance D_c of super capacitor are:

$$\begin{cases} C = D_c \pm AB \\ D_c = C_0 \pm \frac{1}{d} \int (A - A_L) de \end{cases} \quad (2)$$

In the equation, the discharge current and leakage current are set as A and A_L respectively; the charging time is set as e , d is the derivation, and the voltage on both sides of the capacitor before discharge is set as C_0 .

The charging condition of the supercapacitor W reflects the storage condition of the supercapacitor during normal operation. The calculation method of W is:

$$W = \frac{P}{P_c} = \frac{(C_c - C_{\min}) D}{(C_{\max} - C_{\min}) D} = \frac{C_c - C_{\min}}{C_{\max} - C_{\min}} \quad (3)$$

In this equation, the highest working voltage and the lowest working voltage are set as C_{\max} and C_{\min} , the rated working voltage is C_c , and the spare power and the rated power of super capacitor are set as P and P_c .

2.2.2 Control Strategy of Parallel Bidirectional DC/DC Converter

According to the capacitance and voltage data collected by the super capacitor model, the system uses the control strategy of parallel bidirectional DC/DC converter to complete the hybrid energy storage capacitor control which is a fast-tracking control strategy.

The energy storage unit of the super capacitor needs to implement non-static bidirectional energy exchange for the bus voltage, so it is necessary to effectively control the charge of the super capacitor energy storage power supply [10]. Under the expected condition, the hybrid energy storage system of the microgrid can provide all the output power of load bus through the storage battery pack, and control the load voltage stability through DC/DC converter. When the load is abnormal, the super capacitor must be used to provide timely power support because of the soft external characteristics of the battery [11]. Figure 6 depicts the control strategy of the parallel bidirectional DC/DC converter.

The double closed loops of the control voltage and controlling current are set as the control basis, the outer voltage loop is used to control the stability of super capacitor voltage, and the inner current loop is used to control the

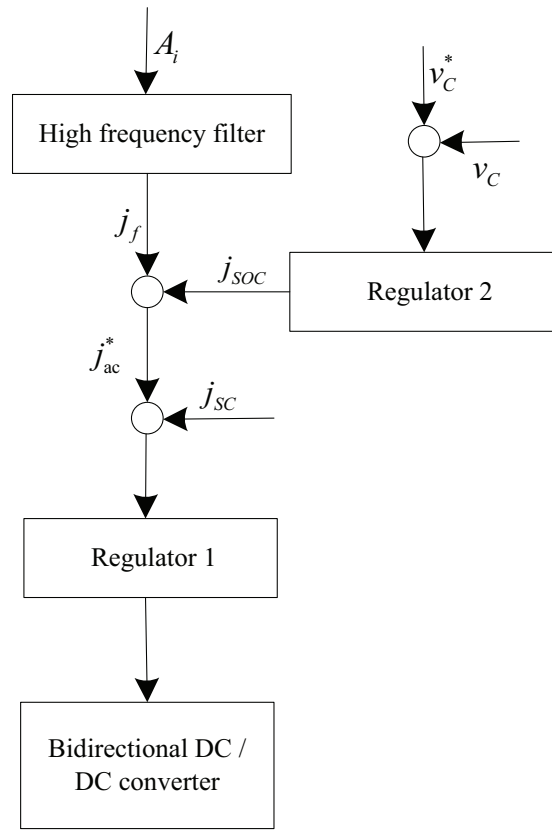

Figure 6 The Schematic Diagram of the Control Strategy

rapid energy transmission [12]. When the load changes, power support is provided quickly to complete the operation of voltage stabilization and current sharing. In Figure 6, the output current of the bus is set as A_i , representing the output power of the battery. The high-frequency high-speed component instruction in the output load of the super capacitor compensation is j_f , which is obtained through the high pass filter. v_C^* is the reference value of the super capacitor voltage v_C . j_{SOC} describes the current instruction of the super capacitor. j_{ac}^* represents the given value of the output current of the super capacitor storage unit, which is established by overlapping j_{SOC} with j_f . The closed-loop control compensation efficiency of regulator 1 is higher than that of regulator 2, which can not only complete the rapid compensation of the parallel bidirectional DC/DC converter for the abnormal load, but also can effectively cope with the abnormal power output of the battery pack [13].

The sliding mode control can resist the indecisiveness of the system, and has great robustness, high response efficiency and self-adaptability to disturbances. When the microgrid system is in the sliding operation mode, it will quickly converge to the control objective [14]. At this time, when regulator 1 is paralleled with the sliding mode controller through PI regulator, the PI regulator will immediately adjust when it senses the abnormality. The sliding mode controller quickly converges and is very robust, which can improve the energy transmission efficiency and ensure a smooth transition.

Regulator 2 uses the piecewise PI regulator control method, and the difference equation of the PI regulator position algorithm is:

$$o = H_p + H_1 r \quad (4)$$

In this equation, H_p and H_1 represent scale, and integral amplification coefficient respectively; and r represents sampling interval.

When the voltage deviation is too large or the super capacitor is discharged, using larger H_p and H_1 can make v_C quickly follow v_C^* and complete the energy output.

When the voltage deviation is small, a larger H_p and H_1 will make a bad effect on the current loop, which will not only enhance the load of regulator 2, but also cause the oscillation of voltage. Thus a smaller r , H_p and H_1 are chosen;

When the super capacitor is charged, there is no higher requirement for charging efficiency and the smaller H_p and H_1 are selected for stability.

By means of the control strategy described above, the fast-tracking control of the hybrid energy storage capacitor can be achieved [15].

3. EXPERIMENTAL ANALYSIS

3.1 Validity Analysis

Figure 7 shows the change of AC bus in the hybrid energy storage system of a microgrid before and after the control of the system mentioned in this paper under the interference of wind speed.

It can be seen from Figure 7 that prior to the system being controlled, the AC bus of the micro grid hybrid energy storage system has frequent fluctuations in energy storage. After the control of the system, there is less fluctuation of the micro grid

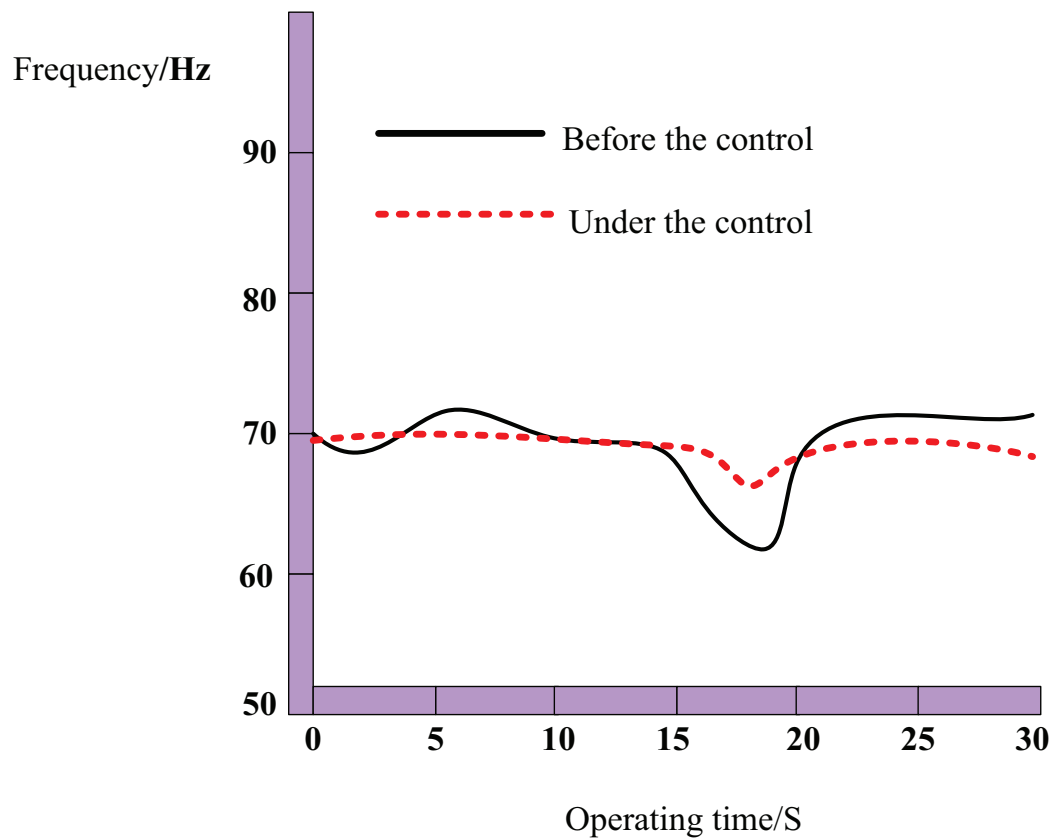

Figure 7 The Fluctuation Curve of Microgrid AC Bus Before and Under the Control of the System Mentioned in This Paper

hybrid energy storage, with only a slight fluctuation occurring when the energy storage function operates for 17s. Therefore, our proposed system can greatly optimize the stability of energy storage. This is because the power density of the super capacitor in this system is larger, which can improve the release efficiency and absorption power, and assist the hybrid energy storage system of the microgrid to recover quickly and become stable.

3.2 Performance Analysis

The equivalent resistance of the hybrid energy storage system in a microgrid is $5 / 7m\Omega$. The equivalent capacitance is 115F; the output voltage of the DC/DC converter is 201V, and the DC / AC converter can reverse the 201V DC voltage to 71V three-phase alternating current. The variation of the three-phase transformer is 71 / 381. The DC end of DC/DC converter is introduced into a 400KW load. The system proposed in this paper is compared with the control system based on PID algorithm and the control system based on BP neural network. The results of the experiment are shown in Figure 8.

In Figure 8 it can be observed that, under the control of the system in this paper, a saw tooth wave appears near 120F, and the wave amplitude is only 3F; under the control of the PID system and the BP neural network system, the capacitance of the hybrid energy storage system of the microgrid fluctuates greatly, with a maximum fluctuation of 13F, showing poor stability. It can be seen that the control effect of the proposed system has the best performance.

Two states are set: microgrid-connected and grid-isolated, and three systems are used for multiple controls. The capacitance stability under control can be seen in Table 1.

According to the data in Table 1, under the two states of grid-connected and grid-isolated, the average stability under control of the proposed system is 99.99%, which is far higher than the other two systems, indicating that our system has the greatest stability and the best control effect.

Under the connected grid state, when the hybrid energy storage system of the microgrid increases the load of 60kW and reduces the load of 60kW, the fluctuations of grid-connected power under the control of three systems are compared. The comparison results are shown in Figure 9:

It can be seen from Figure 9 that in the grid-connected state, when 60kW load is introduced in or eliminated from the microgrid hybrid energy storage system, the response to the grid-connected power under the control of the proposed system is faster. When the load of the microgrid hybrid energy storage system changes, the fluctuation of the grid-connected power can be effectively stabilized, and the control effect is the best.

Three systems are used to control the hybrid energy storage system of microgrid multiple times until the fluctuation of the active power of the microgrid is reasonably stable. The time-consumption data of this process are compared, and the comparison results are shown in Figure 10:

As depicted in Figure 10, when the system takes control for 7ms, the active power of the microgrid hybrid energy storage system tends to be stable, while the other two systems can effectively control the active power of the microgrid hybrid energy storage system after 15ms. Thus,

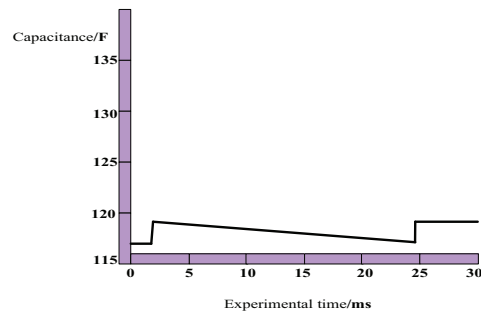

(a) Control Effect of the System proposed in This Paper

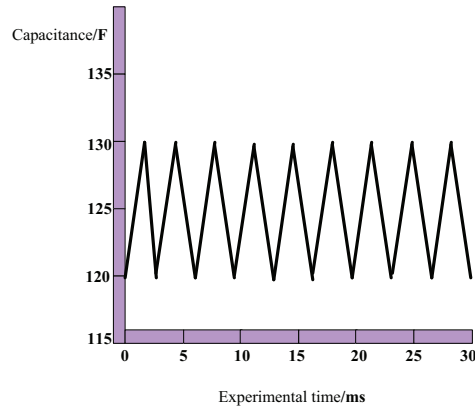

(b) Control Effect of the System Based on PID

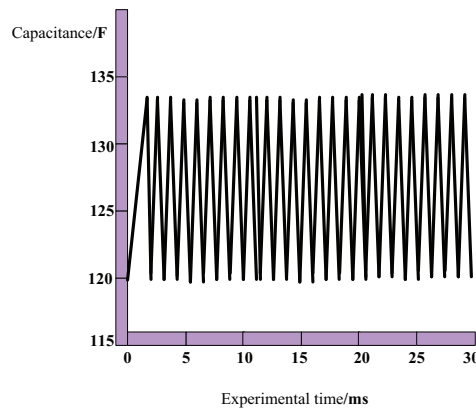

(c) Control Effect of the System Based on BP

Figure 8 Capacitance Fluctuation of DC/DC Converter under the Control the Three Systems

Table 1 Comparison Results of Stability under the Control of Three Systems.

Experimental time	System in this paper	System based on PID algorithm	System based on BP neural network
1	99.99%	87.54%	65.78%
2	99.99%	88.54%	68.96%
3	99.99%	87.77%	68.56%
4	99.98%	87.77%	67.99%
5	99.98%	87.88%	66.67%
6	99.99%	87.66%	66.98%
7	99.99%	87.56%	66.89%
Average	99.99%	87.82%	67.40%

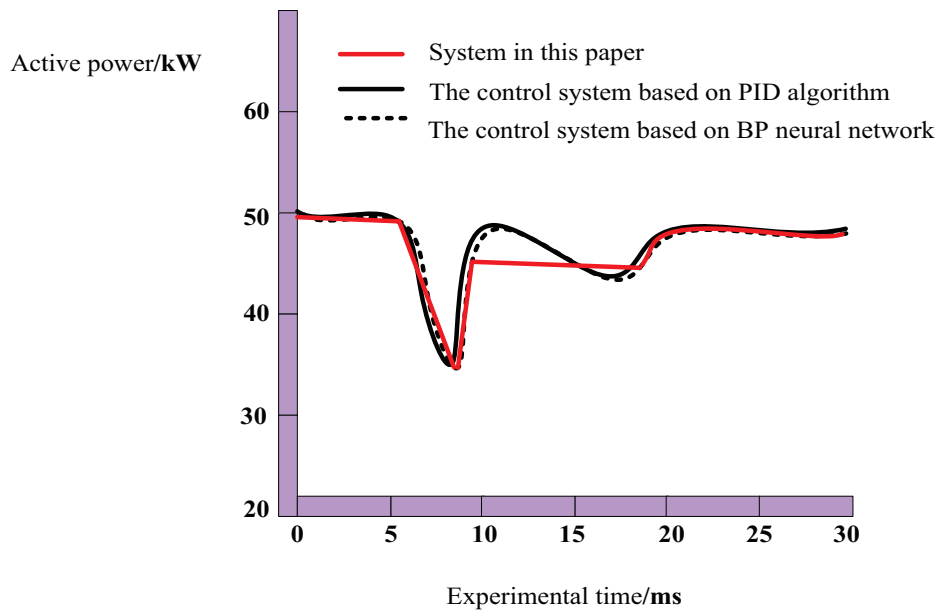

(a) Increase load of 60kW

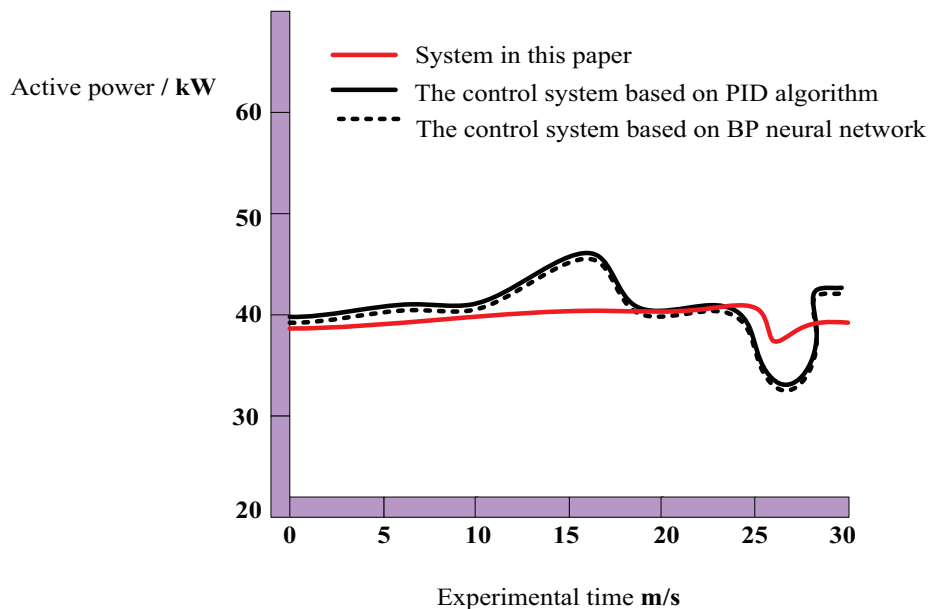

(b) Reduce load of 60kW

Figure 9 Fluctuations of Power in Connected Grid under the Control of Three Systems

the comparison indicates that this system has the best control efficiency.

4. CONCLUSION

The hybrid energy storage of the super capacitor and battery not only meets the operational requirements of the microgrid, but also improves the reliability of energy storage. In this paper, the hybrid energy storage capacitor control system based on microgrid is designed, and the functions of the battery and super capacitor are discussed. The F28M35 central control chip is used to collect the data of battery and

super capacitor to complete the charge and discharge control of super capacitor and battery. After building a super capacitor model and analyzing the detailed voltage and capacitance data, the control strategy of parallel bidirectional DC/DC converter is used to complete the hybrid energy storage capacitor control based on microgrid. Experiments show that the system designed in this paper can control the active power of the hybrid energy storage system within a short time. In the grid-connected and grid-isolated states, the average stability of microgrid capacitance under the control of this system is 99.99%. The system designed in this paper has important application value for the safe and reliable operation of the microgrid.

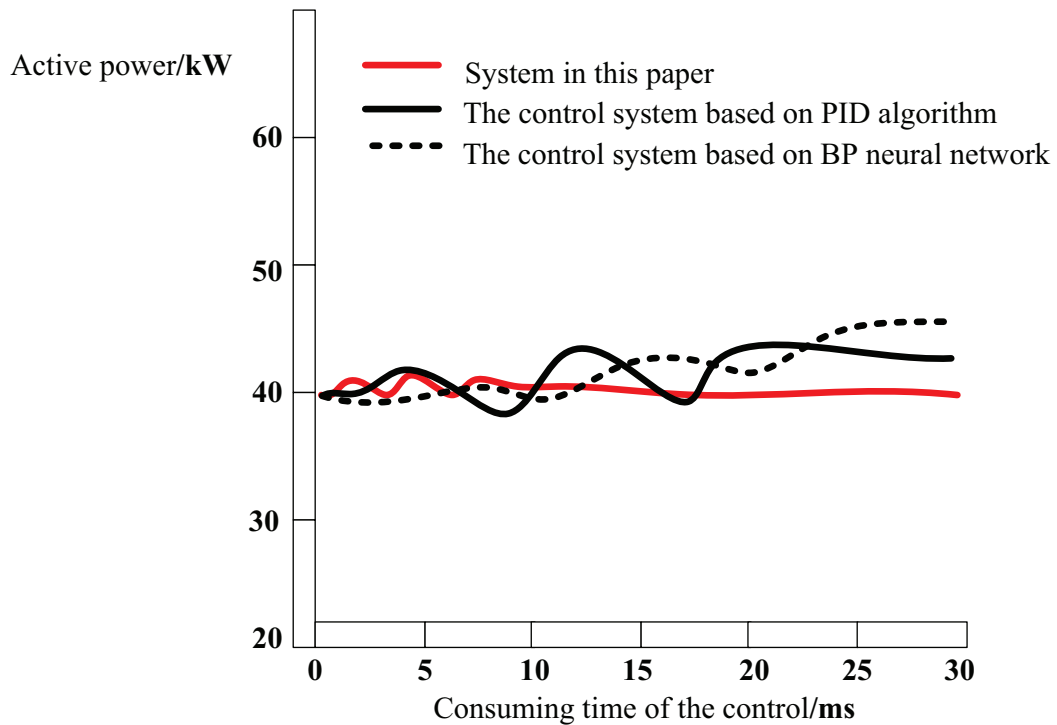

Figure 10 Comparison Results of Consuming Time under the Control of the Three Systems

ACKNOWLEDGEMENT

This study was supported by the Science and Technology Research Project of Jiangxi Provincial Department of Education - Research and Implementation of Three-Level Three-Phase Photovoltaic Inverter System (No. GJJ170553).

REFERENCES

- SUN Jianlong, DOU Xiaobo, ZHANG Zizhong, et al. DC Peer-to-Peer Coordinated Control Strategy of Hybrid Energy Storage System for Microgrid. *Transactions of China Electrotechnical Society*, 2016, 31(4): 194–202.
- HOU Shiyang, YU Haiwei, LI Qi, et al. Adaptive Control Strategy of Hybrid Energy Storage in Microgrid Islanded Operation State. *Automation of Electric Power Systems*, 2017, 41(17): 15–21.
- BI Xiaohui, SUN Tao, MAO Rui, et al. Control Strategy and Protection Switch Optimization of Hybrid Energy Storage System for PV-Storage Microgrid System. *Journal of Chongqing University (Natural Science Edition)*, 2016, 39(6): 11–18.
- HUANG Songbai. Study on the Hybrid Energy Storage System with Super-capacitor and Battery. *Control Engineering of China*, 2016, 23(10): 1486–1491.
- XUE Yalin, ZHOU Jianping, CUI Yi. Simulation Research on Coordinated Control Strategy of Hybrid Energy Storage Based on DC Microgrid. *Electric Machines & Control Application*, 2017, 44(8): 19–25.
- WANG Shuai, ZHAO Ke, AN Quntao, et al. Hybrid Energy Storage Balancing Technology for the Impact Power of Drilling DC Micro Grid. *Electric Machines and Control*, 2017, 21(04): 53–61.
- LI Kai, QIN Wenping, ZHANG Haitao, et al. Control Strategy for Microgrid Energy Management System Including Hybrid Energy Storage. *Proceedings of the CSU-EPSA*, 2016, 28(10): 85–91.
- JIANG W, ZHAI S, QIAN Q, et al. Space-Confined Assembly of All-Carbon Hybrid Fibers for Capacitive Energy Storage: Realizing a Built-to-Order Concept for Micro-Supercapacitors. *Energy & Environmental Science*, 2016, 9(2): 611–622.
- REN Chunguang, ZHAO Yaoming, HAN Xiaoqing, et al. Coordination Control of DC Microgrid with Two DC Buses. *High Voltage Engineering*, 2016, 42(7): 2166–2173.
- SUN Chunjun, NI Chunhua, DOU Xiaobo. Research on Optimal Power Allocation Strategy Based on SOC State Feedback in Hybrid Energy Storage System. *Electrical Measurement & Instrumentation*, 2016, 53(15): 81–88.
- REN Chunguang, HAN Xiaoqing, WANG Peng, et al. Key Technology of AC/DC Hybrid Microgrid and Its Demonstration Project. *Journal of Taiyuan University of Technology*, 2017, 48(3): 486–491.
- Korada N, Mishra M K. Grid Adaptive Power Management Strategy for an Integrated Microgrid With Hybrid Energy Storage. *IEEE Transactions on Industrial Electronics*, 2017, 64(4): 2884–2892.
- HUANG Wei, XIONG Weipeng, CHE Wenxue. Application of Fuzzy Control in Hybrid Wind/PV Microgrid with Energy Storage. *Modern Electric Power*, 2017, 34(1): 30–36.
- QIN J, WU Z S, FENG Z, et al. Simplified fabrication of high areal capacitance all-solid-state micro-supercapacitors based on graphene and MnO₂ nanosheets. *Chinese Chemical Letters*, 2018, v.29(04): 42–46.
- ZHOU Pengwei, CHENG Zhijiang, SUN Ao, et al. Research on Optimal Control of Hybrid Energy Storage in Micro-Grid Power Supply System. *Computer Simulation*, 2016, 33(12): 138–142.

